

ONE STOP SOLUTION FOR
ALL HOSPITAL NEEDS



ENT PRODUCTS

— Range —



QUALITY



TRUST



24 X 7
SERVICE



Follow us on



ENT Products

1. ENT OPD Setup

✓ ENT OPD Setup.....3

2. ENT Microscopes

✓ ENT Microscope.....4

3. ENT Chair

✓ ENT Chair.....6

4. Tympanometer

✓ Tympanometer.....7

5. LED Head Light

✓ LED Head Light9

6. Otology

✓ Pocket Otoscope.....10

✓ Stapedectomy Set.....11

7. Rhinology Sinus copy

✓ Sinus cope.....12

✓ Rhinoplasty Set.....13

✓ FESS Instrument Set.....14

✓ Sept o-Rhinoplasty Set.....15

8. Tonsillectomy

✓ Tonsillectomy Set.....17

9. Laryngoscopy

✓ Laryngoscope.....18

✓ Video Laryngoscope.....19

✓ Laryngoscopy Instrument Set.....21

10. Bronchoscopy

✓ Rigid Bronchoscope Set.....22

11. Esophagoscopy

✓ Esophageal Instrument Set.....23

12. Micro Debrider

✓ Micro Debrider.....24

13. ENT Surgery Instrument Set

✓ Austin Middle Ear Set.....25

✓ Myringotomy Set.....26

✓ Tympanoplasty Set.....27

✓ Mastoid Surgery Set29

✓ Sept o-Rhinoplasty Set.....31

✓ ParaNasal Instrument Set.....33

✓ DCR Surgery Set.....34

✓ FESS Instrument Set.....35

✓ Tonsillectomy Set & Adenoidectomy Se.....36

✓ Tracheotomy Set.....38

✓ Micro Laryngeal Set.....39

14. Tuning Fork

✓ Harmonic Tuning Fork.....40

✓ Tuning Fork.....41

ENT OPD Setup – 22A01

Advin Health Care offers ENT OPD Set with International quality standards. It is used by ENT Specialist for Observe ear, nose, throt.

Advanced Features:

- ✓ Built-in twin halogen light dource 150w with brightness control
- ✓ Built-in suction machine with pressure gauge (Twin Jars)
- ✓ Slim LED X-Ray view box
- ✓ Head light band hanger
- ✓ Endoscope holders
- ✓ Otoscope holder
- ✓ Waste container/Cotton gauze box
- ✓ Nasal cautery with temp. control
- ✓ Anti fog device/Mirror warmer
- ✓ LED pen light for endoscope illumination
- ✓ Fiber Optic cable 4.5 mm diameter & 7.5 feet length
- ✓ Stainless steel instruments trays with cover
- ✓ Medicine bottles
- ✓ Sliding drawers for storage



Product Code:

Product	Size	Code
ENT OPD Setup	-	22A01

ENT Microscope – 22B01

Advin Health Care offers ENT Microscope with International quality standards. ENT specialists rely on ENT microscopes to visualize the surgical site and enable them to perform a wide range of surgical procedures with a deeper and more detailed view.

Advanced Features:

- ✓ Innovative design
- ✓ Straight Optical system on Floor Stand with Cold light Co-axial illumination
- ✓ Adjustable Stand for Different Viewing Angles
- ✓ Highly versatile with Latest 90 deg



Technical Specification:

Specification

Binocular Tubes	Fixed at 45° or 90 Fixed at 90
Eye Pieces	10 x wide field
Magnification	5 x to 25x
magnification objective lens	F=250 mm,
Field of view	50mm
IPD adjustment	55 mm to 75 mm
Fine Focusing	Motorized foot control system
Illumination	90 W LED lux 80000
Field of Illumination	70 mm
Arm	Counter balanced pantographic arm with 320-degree rotation

Vertical Range of counter Balanced Arm	350 mm to 550 mm
Floor stand	Mobile floor stand on castor wheels for easy handling and absolute stability.
Dimension	600 mm x 500 mm x 1500 mm
Weight	65 Kg
Power	240 V AC / 50 Hz

Product Code:

Product	Size	Code
ENT Microscope	-	22B01



ENT Chair – 22C01

Advin Health Care offers ENT Chair with international quality standards. The power exam chair is primarily used in examination rooms for general ear, nose and throat (ENT) examinations and minor procedures.

Advanced Features:

- 🪑 Fully Motorized Height Adjustment via Foot Control
- 🪑 Chair can be Adjusted to Horizontal Position
- 🪑 Foldable Arm Rest
- 🪑 High density PU foam
- 🪑 Made with High Quality Material for Supreme Comfort
- 🪑 Rotate the Chair



Technical Specification:

Technical Specification

Height	550 mm – 750 mm
Vertical	200 mm
Chair Rotate	180°
Chair Reclining	95° to 180°
Load Capacity	150 Kg
Power Supply	230 V AC / 50 Hz
Power Consumption	60W

Product Code:

Product	Size	Code
ENT Chair	-	22C01

Tympanometer – 22D01

Advin Health Care offers Tympanometer with International quality standards. Tympanometer is typically used to detect or rule out several things the presence of fluid in the middle ear, a middle ear infection, a hole in the eardrum (perforation), or Eustachian tube dysfunction.

Advanced Features:

- 👂 Diagnostic Middle Ear analyzer
- 👂 Performing incredibly fast and reliable automatic sequences of tympanometry and reflex threshold tests,
- 👂 manual reflex and reflex decay tests, ETF test, and high frequency tympanometry
- 👂 User friendly interface,
- 👂 Two user Programmable auto test sequences
- 👂 Tympanometry and ipsi/contra reflex tests



Technical Specification:

Measurement System

Probe Tone	226 Hz at 85 dB SPL
Compl. Range	0.2 to 8.0 ml (at 226 Hz)
Pressure Range	+400 to – 600 daPa

Tympanometry

Type of Test	Automatic tympanometry
Press. change:	50, 100, 200, 300 daPa/sec, auto

Acoustic Reflex

Stimulation	Ipsi and contralateral
Available tests	Automatic threshold, fixed intensity, growing intensity
Stimuli	250 (contra), 500, 1k, 2k, 4k Hz
Maximum int	110 dB HL (ipsi), 120 dB HL (contra)
Stim. duration	From 0.5 to 2.5 sec (selectable)
Reflex decay	10 or 20 sec
Automatic tests	Quick A and B (seq. of tympanometry and reflex)

Device Specification

Memory	1 tympanometry + 8 reflex + 4 decay record. per ear
Display type	Colour graphical
Display size/res	4.3"/ 480 x 272 pixel
Printer	Built-in thermal printer (opt.)
Language	Multilingual interface
PC interface	USB (driverless)
Compatible sw	Inventis Maestro (stand-alone or Noah module)
Dimensions	32 x 32 x 9 cm
Weight	2.5 Kg

Product Code:

Product	Size	Code
Tympanometry	-	22D01

LED Head Light - 2G04

Advin Health care provides Doctor LED Head light with international Quality Standards. The head-light is designed for examination and all types of surgical operations including microsurgery.

Advanced Features:

- 🔌 Variable intensity LED light
- 🔌 No heat in the light system
- 🔌 Rechargeable Li-Ion battery pack
- 🔌 Range of magnification and focal length loupes
- 🔌 Crisp and clear images from high grade glass, multi-coated loupes



Technical Specification:

Technical Specification

Light Source Type	LED
Light Color	White
Diameter	80mm
Fluctuation Distance	125 mm
Battery	7.2 Li-Ion Battery
Input Voltage	110 – 240 VAC 50/60 Hz
Power	10 W
Weight	69 gms

Product Code:

Product	Size	Code
LED Head Light	-	2G04

Pocket Otoscope – 22E01

Advin Health Care offers Pocket Otoscope with international quality standards. Pocket Oscopes are relatively simple devices that are excellent tools for the diagnosis of disease in the ear, nose, and throat.

Advanced Features:

- 👂 Compact and Light weight
- 👂 LED Otoscope
- 👂 Sure, Colour bulb technology – see the true tissue colour
- 👂 LED bulbs are rated for up to 20,000 hours of use and do not require replacement
- 👂 longer life from 2 AA batteries
- 👂 Lightest 2 battery pocket otoscopes
- 👂 2.5 x magnification Insufflation port



Product Code:





Product	Size	Code
Pocket Otoscope	-	22E01

Health Care

Stapedectomy Set – 22E02

Advin Health Care offers Stapedectomy Set with international quality standards.

Advanced Features:

-  Smooth Surface
-  Made in High Grade Medical Material
-  Corrosion resistance
-  Autoclavable

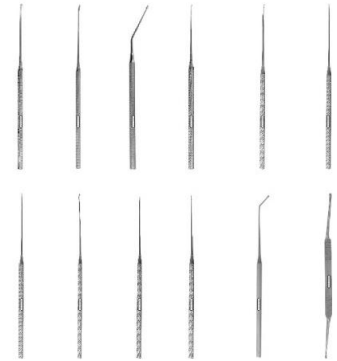

Instrument Set:

SR. NO.	Product	QTY
1	Piston holding Forceps	1
2	Crimper	1
3	Measuring Jig	1
4	Hook 45°	1
5	Hook 90°	1
6	Pik 90°	1
7	Elevator	1
8	Sharp pointed needle	1
9	Measuring Devices	2
10	Perforator	2
11	Instrument Tray	1

Product Code:

Product	Size	Code
Stapedectomy Set	-	22E02

Sinuscope – 22F01

Advin Health Care offers Sinuscope with International quality standards. The Sinuscope is indicated for use in, but not limited to such procedures as examination of sinus passages and cavities, removal of abnormal growths such as polyps and facio-plastic surgery.

Advanced Features:

- 👁️ Built with High Quality Stainless Steel
- 👁️ High Performance Optics
- 👁️ Sapphire Lens making it scratch resistant
- 👁️ Autoclavable



Product Code:

Product	Size	Code
Sinuscope	4mm x 0 degree	22F014000
Sinuscope	4mm x 30 degree	22F014030
Sinuscope	4mm x 70 degree	22F014070
Sinuscope	2.7mm x 0 degree	22F012700
Sinuscope	2.7mm x 30 degree	22F012730
Sinuscope	2.7mm x 70 degree	22F012770

Rhinoplasty Set – 22F02

Advin Health Care offers Rhinoplasty Set with international quality standards. Rhinoplasty instruments set with a wide range and remarkable quality. Rhinoplasty instruments set covering every single fundamental apparatus required for nose surgery.

Advanced Features:

- 👉 Made of High Quality Stainless Steel
- 👉 Corrosion Proof
- 👉 Reusable
- 👉 Autoclavable

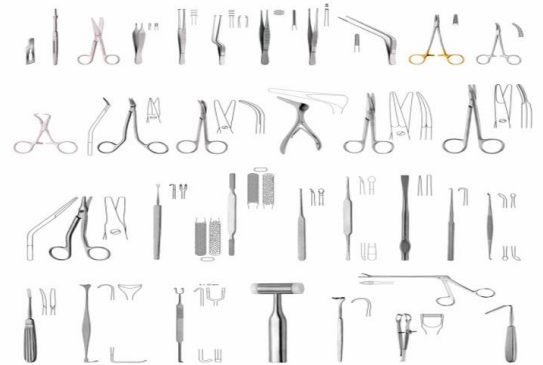

Instrument Set:

No.	Instruments	Quantity
1	Killan Speculum	4
2	Freer Elevator	2
3	Lacs	2
4	Mallet	1
5	Gauge	2
6	Tilly Nasal Packing	2
7	Nasal Suction	4
8	ST clair Thomson	1
9	Turbinectomy Scissor	1
10	Forman Scissor	1
11	Alar Retractor	2
12	Chisel	3
13	Osteotomes	2
14	Aufright Retractor	1
15	RASP	2





Product Code:

Product	Size	Code
Rhinoplasty Set	-	22F02

FESS Instrument Set – 22F03

Advin Health Care manufacturer FESS (Functional endoscopic sinus surgery) Instrument Set is international quality Standard. It is also called ENT Instrument set.

Advanced Features:

-  Smooth Surface
-  Made in High Grade Medical Material
-  Corrosion resistance
-  Autoclavable



Set of instruments

SR. NO.	Product	QTY
1	SS Tray with cover	1
2	Suction cannula	7
3	Lucs Forceps	1
4	Sickle Knife	1
5	Scissor 7"	1
6	Nasal Packing Forceps	2
7	Suction Cvd Tip	2
8	Micro Scissor 6"	2
9	Punch Forceps – Straight	4
10	Blakesley wild (upper Bite) 45"	3
11	Blakesley wild (upper Bite) 90"	2
12	Blakesley wild (Lower Bite)	2





Product Code:

Product	Size	Code
FESS Instrument Set	-	22F03

Sept o-Rhinoplasty Set – 22F04

Advin Health Care manufacturer Sept o-Rhinoplasty Instrument Set is international quality Standard.

Advanced Features:

-  Smooth Surface
-  Made in High Grade Medical Material
-  Corrosion resistance
-  Autoclavable

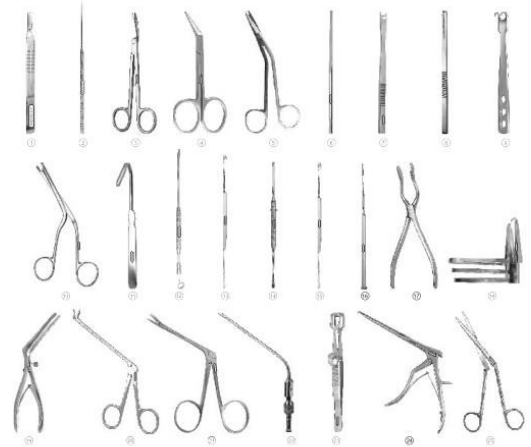

Set of instruments:

SR. NO.	Product	QTY
1	Nasal -Speculae Thudichum No.1	2
2	Nasal -Speculae Thudichum No.2	2
3	Nasal -Speculae Thudichum No.3	2
4	Suction cannula No. 2	1
5	Suction cannula No. 3	1
6	Suction cannula No. 4	1
7	Greanulation health forceps 8 cm	3
8	Wax hook 15 cm	2
9	Skin hook gillies	2
10	Freer elevator (4mm)	2
11	Nasal Gouge Tilley	1
12	Negus Dissector	2
13	Angular Scissor	1
14	Elevators Atriotomy Tamarkin D/E	1
15	Scissor Metzenbaum 6" CVD	1
16	Alar Retractor	1
17	Nasal Gouge Tilley	1
18	Killer Retractor Double Hook	1
19	Sickle Knife Small	2
20	McDonald's Dissector	2
21	Heymann Nasal Turbinectomy Scissor 18 cm	1

22	Massing Elevators with Graduation	1
23	Ballenger Chisel	1
24	SMR Elevator	1
25	Dissecting Forceps Adson Tooth 5"	1

Product Code:

Product	Size	Code
Sept o-Rhinoplasty Set	-	22F04



Tonsillectomy Set – 22G01

Advin Health Care manufacturer Tonsillectomy Set with international quality Standards.

Advanced Features:

- 👉 Smooth Surface
- 👉 Made in High Grade Medical Material
- 👉 Corrosion resistance
- 👉 Autoclavable

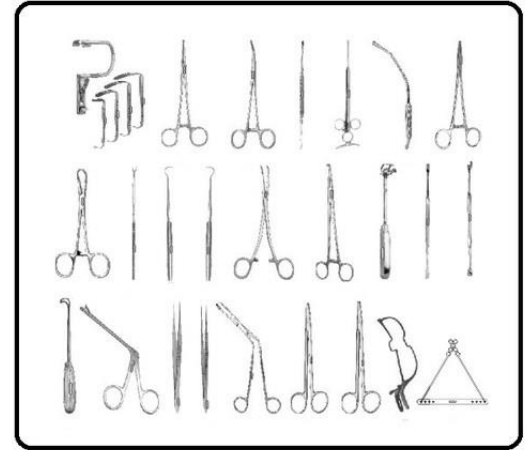

Set of instruments

SR. NO.	Product	QTY
1	Tonsillectomy Artery Forceps	2
2	Tonsil Artery Negus	1
3	Tonsil Scissor 8"	1
4	Dennis Brown Forceps	1
5	Tonsil Val Sham	1
6	Needle Holder Crile wood 6"	1
7	Negus pusher Knot Tier	1
8	Tonsil Snair	1
9	Tonsil Dissector & Pillar Retractor	1
10	Yankur Suction	1
11	Adenoid curette	2
12	Waugh Dissecting Forceps	2
13	Mouth gag 5 blade SET	1
14	Bipod Stand SET	1
15	Joining Mouth gag	1

Product Code:

Product	Size	Code
Tonsillectomy Set	-	22G01

Laryngoscope – 22H01

Laryngoscope is a small device to look into your throat and larynx, or voice box. This procedure is called laryngoscopy. They may do this to figure out why you have a cough or sore throat, to find and remove something that's stuck in there, or to take samples of your tissue to look at later.

Advanced Features:

- ✓ Unobstructed View and conventional Lamp type
- ✓ Fits on all hook-on handles and unique anti-seize spring action
- ✓ Full Stainless Steel construction and optimal smooth action
- ✓ Precision made for ruggedness and high quality



Product Code:

Product	Size	Code
Laryngoscope	Adult	22H01A
Laryngoscope	Child	22H01C

Video Laryngoscope – 22H02

Video laryngoscope used for indirect laryngoscopy in which the clinician does not directly view the larynx. Instead, visualization of the larynx is performed with a fiberoptic or digital laryngoscope inserted transnasally or transorally.

Advanced Features:

- ✓ Lightweight and ergonomic design
- ✓ 2.5-inch display provides high-performance visualization capabilities for every intubation
- ✓ Battery Backup 18hr
- ✓ disposable Video Laryngoscope
- ✓ Fits on all hook-on handles and unique anti-seize spring action
- ✓ Full Stainless Steel construction and optimal smooth action
- ✓ Precision made for ruggedness and high quality



Technical Specification:

Technical Specification

Camera Resoulation	0.3 Millian Piex
Vision Angle	> 40°
Battery Backup	> 18 hr
Display	2.5" LCD
Display Rotate Up Down	0° - 90°
Light Souce	Buit in high power waterproof LED Light
Light	> 2600 Lux
Camera	Double anti-fogging, no blind area for intubation
Connection	Imported medical waterproof aviation special connection design to ensure the image transmisson normally
Laryngoscope blade	International newly designed universal laryngoscope piece, in line with human engineering, with Asptic Packingging, use directly, avoid cross infection
Blade type and material	Cross infection

Blade size	Adult
Weight	203g
Power Supply	100 – 240 V, 50/60 Hz
Working Temp	5° – 40° C
Humidity	<93%
Atmospheric Pressure	860hpa – 1060 hPa

Product Code:

Product	Size	Code
Video Laryngoscope	-	22H02



Laryngoscopy Instrument Set – 22H03

Advin Health Care Offers Laryngoscopy Instrument Set with international quality standards. Laryngoscopy instrument set is used in ENT surgery.

Advanced Features:

- ✓ Made in High Grade Stainless Steel
- ✓ Reusable
- ✓ Autoclavable
- ✓ Corrosion Proof

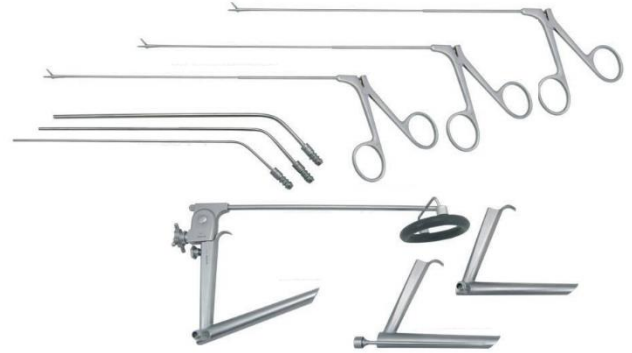

Instrument Set:

Sr. No.	Item	QTY
1	Laryngoscope (S/M/L)	3
2	Chest Stand	1
3	MLS Cup Forceps	1
4	MLS Scissor	1
5	MLS Crocodile Forceps	1
6	MLS Suction	3
7	Laryngoscope with endoscopy Holder	1

Product Code:

Product	Size	Code
Laryngoscopy Instrument Set	-	22H03

Rigid Bronchoscope Set – 22I01S

Rigid Bronchoscope is designed for use in interventional bronchoscopy. It combines innovative features for easier handling and a wide compatibility with essential bronchoscopy instruments.

Advanced Features:

- ✓ Made in high grade stainless steel material
- ✓ Reusable & Autoclavable
- ✓ Simplified cleaning due to new, patented design
- ✓ Optimal vision
- ✓ Good suction possibilities

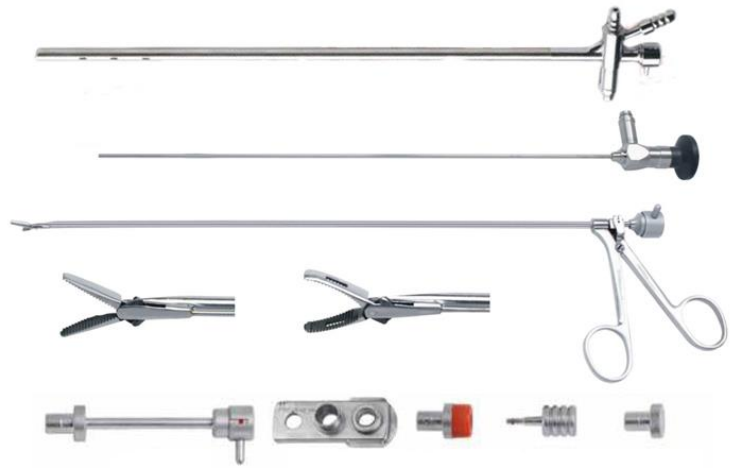

Instrument set:

- 👉 Bronchoscope – 3 mm x 360 mm – 0 Degree
- 👉 Bronchoscope Sheath 5 mm x 280 mm
- 👉 Bronchoscope Forceps – 4.3 mm x 330 mm
- 👉 Bronchoscope Optical Forceps – 4.3 mm x 330 mm
- 👉 Bronchoscope bridge
- 👉 Sliding Connector
- 👉 Connector with cap
- 👉 Connector with protective glass
- 👉 End Stopper

Product Code:

Product	Size	Code
Rigid Bronchoscope Set	-	22I01S

Esophageal Instrument Set – 22J01S

esophageal instrument set is designed for using this esophagoscope to stripe, cut and irrigation. It combines innovative features for easier handling and a wide compatibility with essential Esophageal instruments.

Advanced Features:

- ✓ Made in high grade stainless steel material
- ✓ Reusable & Autoclavable
- ✓ Simplified cleaning due to new, patented design
- ✓ Optimal vision
- ✓ Good suction possibilities

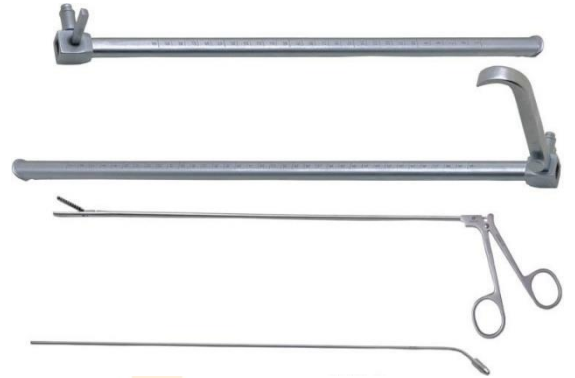

Instrument set:

- 👉 Esophagosopes (s/m/l) – 3Nos
- 👉 Esophagoscopy Forceps – 3 Nos
- 👉 Suction – 3 Nos
- 👉 Forigen Body Forceps – 1 No
- 👉 Formalin Chamber - 1 No

Product Code:

Product	Size	Code
Esophageal instrument set	-	22J01S

Micro Debrider – 22K01

Advin health care offers Micro Debrider with international quality standard. Micro Debrider / Nasal Power Drill is Used in functionality functional endoscopic surgery and Endoscopic sinus surgery.

Advanced Features:

- 👉 Low Noise
- 👉 Import stainless steel Material
- 👉 Easy to use
- 👉 Foot switch control
- 👉 Speed: 4000 RPM
- 👉 Reverse / Forward cutting
- 👉 Hand pieces With suction



Set Includes:

- 👉 Control Unit – 01
- 👉 Hand Piece with suction – 1
- 👉 Cutting Blade – 04
- 👉 Foot Switch – 01
- 👉 Power Cable - 01





Product Code:

Product	Size	Code
Micro Debrider	-	22K01

Austin Middle Ear Set – 22M01

Advin Health Care manufacturer Austin Middle Ear Set with international quality standards.

Advanced Features:

-  Smooth Surface
-  Made in High Grade Medical Material
-  Corrosion resistance
-  Autoclavable



Set of instruments:

SR.No.	Product	QTY
1	Plaster First Incision Knife	1
2	Sickle Knife	1
3	Myringotomy Knife	1
4	Circular Cutting Knife 60	1
5	Rosen Elevator for Lifting Drum	1
6	Wall stein Straight Needle Sharp & Blunt	1
7	Wall stein Needle Curved Sharp & Blunt	1
8	Rosen Curette Curved Straight Shaft	1
9	Larkin Perforator	1
10	House Measuring Rod 3.5/4.0/4.5mm	1
11	Hook Ball End Bent 45	1
12	House Curette Double Ended Slightly	1

Product Code:

Product	Size	Code
Austin Middle Ear Set	-	22M01

Myringotomy Set – 22M02

Advin Health Care manufacturer Myringotomy Set is international quality Standard.

Advanced Features:

- 👂 Smooth Surface
- 👂 Made in High Grade Medical Material
- 👂 Corrosion resistance
- 👂 Autoclavable



Set of instruments:

SR. NO.	Product	QTY
1	Ear speculum by Hartmann set of 4	1
2	Micro ear forceps By Hartmann 8 cm ST	1
3	Ear Curette 15 cm Blunt	1
4	Sickle Knife 16.5 cm cvd	1
5	Needle Wullstein 16.5 cm CVD	1
6	Micro Pick 90 degree Angled 16.5 cm	1
7	Adapter 5.2 cm	1
8	Suction cannula 1.0 mm	1
9	Suction cannula 1.3 mm	1
10	Suction cannula 1.5 mm	1
11	Suction cannula 2.0 mm	1





Product Code:

Product	Size	Code
Myringotomy Set	-	22M02

Tympanoplasty Set – 22M03

Advin Health Care manufacturer Tympanoplasty Set is International quality Standard.

Advanced Features:

-  Smooth Surface
-  Made in High Grade Medical Material
-  Corrosion resistance
-  Autoclavable



Set of instruments:

SR. NO.	Product	QTY
1	Hartman Ear Speculum Black Finish (Set Of 4)	1
2	Aural Speculum Shea	1
3	Plaster Retractor 2x2 Prongs	1
4	Wullstein Retractor 3x3 Pongs	1
5	Tilley Dressing Forceps	1
6	Suction Cannula (Any Size 5 Nos.)	1
7	Suction Adopter	1
8	Mastoid Suction Cannula	1
9	Micro Crocodile Forceps Serrated Straight	1
10	Micro Crocodile Cup Forceps Straight	1
11	Micro Crocodile Scissors Straight	1
12	Mc. Gee Wire Crimper	1
13	House Dieter Malleus Nipper Up	1
14	Hand Retractor	1
15	Wullstein Needle Straight	1
16	Wullstein Needle Slightly Curved	1
17	Plaster Flap Knife for Incision	1
18	Rosen Circular Knife 45 Angled	1
19	Sickle Knife	1
20	Micro Pick 45 0.8mm	1
21	Micro Pick 90 Angled	1
22	Micro Instruments Case with Double Silicon Matt Large	1

Product Code:





Product	Size	Code
Tympanoplasty Set	-	22M03



Mastoid Surgery Set – 22M04

Advin Health Care manufacturer Mastoid Surgery Set is International quality Standard.

Advanced Features:

-  Smooth Surface
-  Made in High Grade Medical Material
-  Corrosion resistance
-  Autoclavable

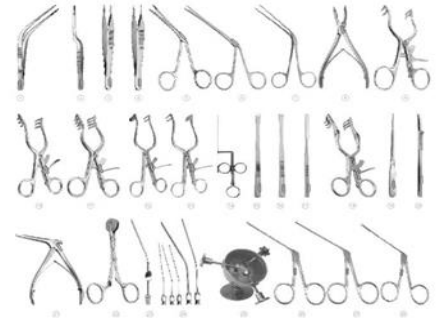

Set of instruments:

SR. NO.	Product	QTY
1	Wild Aural Forceps Large	1
2	Fagge Aural Bayonet Forceps	1
3	Adson Plain Forceps	1
4	Adson Forceps with 1x2 Teeth	1
5	Hartman Aural Forceps	1
6	Ossicle Holding Forceps	1
7	Tilley Aural Forceps	1
8	Lemert Ronguer Curved	1
9	Plaster Self Retaining Retractor 2x2 Prongs	1
10	Wullstein Self Retaining Retractor 3x3 Prongs	1
11	Wullstein Self Retaining Retractor 4x4 Prongs	1
12	Plaster Jansen Retractor Solid Blade Left	1
13	Plaster Jansen Retractor Solid Blade Right	1
14	Glegg Aural Snare	1
15	Jansen Chisel	1
16	Jansen Osteotome	1
17	Jenkins Gouge	1
18	Cone Self Retaining Adjustable Retractor	1
19	Lemert Mastoid Curette	1
20	Farabeuf Elevator Curved	1
21	Kerrison Bone Punch	1
22	Houses Graft Press Forceps	1
23	Mastoid Suction Tube	1
24	Suction Tube - Set & Holder	1

25	Temporal Bone Holder	1
26	Micro Aural Crocodile Forceps	1
27	Micro Crocodile Cup Forceps	1
28	Micro Crocodile Scissors	1

Product Code:





Product	Size	Code
Mastoid Surgery Set	-	22M04



Sept o-Rhinoplasty Set – 22F04

Advin Health Care manufacturer Sept o-Rhinoplasty Instrument Set is International quality Standard.

Advanced Features:

-  Smooth Surface
-  Made in High Grade Medical Material
-  Corrosion resistance
-  Autoclavable

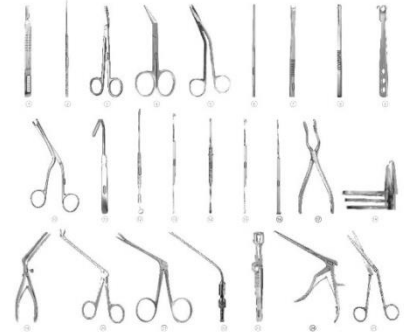

Set of instruments:

SR. NO.	Product	QTY
1	Nasal -Speculae Thudichum No.1	2
2	Nasal -Speculae Thudichum No.2	2
3	Nasal -Speculae Thudichum No.3	2
4	Suction cannula No. 2	1
5	Suction cannula No. 3	1
6	Suction cannula No. 4	1
7	Granulation health forceps 8 cm	3
8	Wax hook 15 cm	2
9	Skin hook gillies	2
10	Freer elevator (4mm)	2
11	Nasal Gouge Tilley	1
12	Negus Dissector	2
13	Angular Scissor	1
14	Elevators Atriotomy Tumarkin D/E	1
15	Scissor Metzenbaum 6" CVD	1
16	Alar Retractor	1
17	Nasal Gouge Tilley	1
18	Killner Retractor Double Hook	1
19	Sickle Knife Small	2
20	McDonald's Dissector	2
21	Heymann Nasal Turbinectomy Scissor 18 cm	1
22	Massing Elevators with Graduation	1
23	Ballenger Chisel	1
24	SMR Elevator	1
25	Dissecting Forceps Adson Tooth 5"	1

Product Code:





Product	Size	Code
Sept O-Rhinoplasty Set	-	22M04



ParaNasal Instrument Set – 22M06

Advin Health Care manufacturer Nasal Instrument Set is International quality Standard.

Advanced Features:

-  Smooth Surface
-  Made in High Grade Medical Material
-  Corrosion resistance
-  Autoclavable

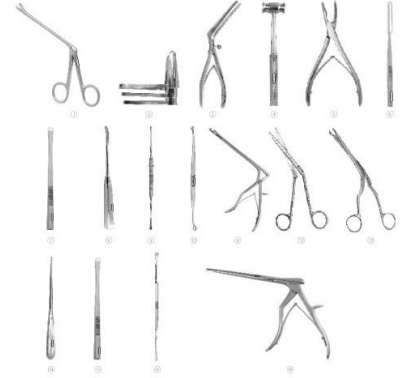

Set of instruments:

SR. NO.	Product	QTY
1	Blaksely Nasal Forceps Straight	1
2	Thudicum Nasal Speculum	2
3	Killian Speculum Set Of 4	3
4	Mallet	2
5	Bayor Rongeur	1
6	Trautman Mastoid Gauge	1
7	Jansen Chisel	2
8	Wullstein Raspatory Curved	2
9	Freer Elevator Double Ended	2
10	Faulkner Antrum Curette	1
11	Citeli Antrum Punch	1
12	Heymann Nasal Turbinectomy Scissors	1
13	Hartman Nasal Cutting Forceps	1
14	Hale Antrum Curette	1
15	Passow Chisel	1
16	Masing Elevator Double Ended	1
17	Metzenbaum Scissors Curved	1
18	Antrum Punch Through Cutting	1





Product Code:

Product	Size	Code
Paranasal instrument Set	-	22M06

DCR Surgery Set – 22M07

Advin Health Care manufacturer DCR Surgery Set is international quality standard.

Advanced Features:

-  Smooth Surface
-  Made in High Grade Medical Material
-  Corrosion resistance
-  Autoclavable

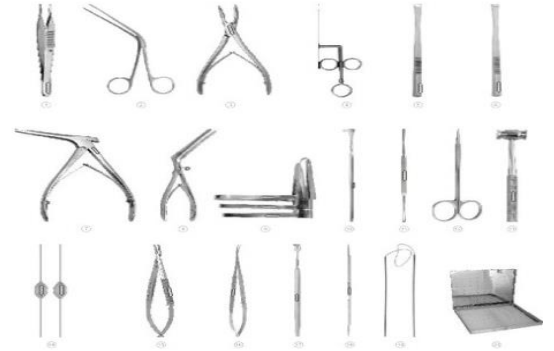

Set of instruments:

SR. NO.	Product	QTY
1	Adson Tooth Forceps	1
2	Tilley Packing Forceps	1
3	Lempert Rongeur Curved	1
4	Jansen Chisel	1
5	Osteotome	1
6	Jenkin Gauge	1
7	Kerrison Nasal Speculum	1
8	Killian Nasal Speculum	1
9	Thudicum Nasal Speculum	1
10	Cottle Upper Lateral Retractor	1
11	Periosteal Elevator	1
12	Fine Dressing Scissors	1
13	Mallet	1
14	Bowman Lacrimal Probe Set (Set Of 4)	1
15	Spring Needle Holder	1
16	Spring Scissors Curved	1
17	Catspaw Retractor	1
18	Lacrimal Dilator	1
19	Lacrimal Intubation (Stent)	1
20	Sterilization Box with Double	1





Product Code:

Product	Size	Code
DCR Surgery Set	-	22M07

FESS Instrument Set – 22F03

Advin Health Care manufacturer FESS (Functional endoscopic sinus surgery) Instrument Set is international quality Standard. It is also called ENT Instrument set.

Advanced Features:

-  Smooth Surface
-  Made in High Grade Medical Material
-  Corrosion resistance
-  Autoclavable



Set of instruments

SR. NO.	Product	QTY
1	SS Tray with cover	1
2	Suction cannula	7
3	Lucs Forceps	1
4	Sickle Knife	1
5	Scissor 7"	1
6	Nasal Packing Forceps	2
7	Suction Cvd Tip	2
8	Micro Scissor 6"	2
9	Punch Forceps – Straight	4
10	Blakesley wild (upper Bite) 45"	3
11	Blakesley wild (upper Bite) 90"	2
12	Blakesley wild (Lower Bite)	2

Product Code:

Product	Size	Code
FESS Instrument Set	-	22F03

Tonsillectomy Set & Adenoidectomy Set

– 22M09

Advin Health Care manufacturer Tonsillectomy Set & Adenoidectomy Set Instrument Set is international quality standard.

Advanced Features:

- 👉 Smooth Surface
- 👉 Made in High Grade Medical Material
- 👉 Corrosion resistance
- 👉 Autoclavable

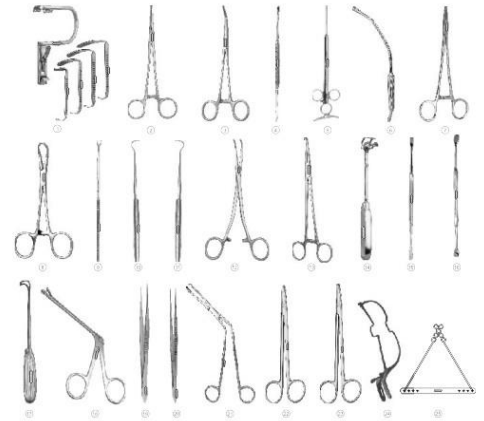

Set of instruments:

SR. NO.	Product	QTY
1	Mouth Gag Davis Set Of 5 Blades	1
2	Tonsil Artery Forceps Straight	1
3	Tonsil Artery Forceps Curved	1
4	Tonsil Elevator	1
5	Bruening Tonsil Snare	1
6	Yankur Suction Tube	1
7	Needle Holder TC Coated	1
8	Backhaus Towel Forceps	1
9	Negus Pusher Knot Tier	1
10	Irwin Moore Tonsil Needle Right	1
11	Irwin Moore Tonsil Needle Left	1
12	Negus Tonsil Artery Forceps Long Curved	1
13	Negus Tonsil Artery Forceps Long Straight	1
14	Backman Adenoid Curette with Case Set Of 3	1
15	Negus Tonsil Retractor	1
16	Negus Tonsil Piller Dissector & Retractor	1
17	Backman Adenoid Curette Without Cage Set Of 2	1
18	Hartman Chachotome	1
19	Waugh Tonsil Dissecting Forceps	1
20	Waugh Tonsil Dissecting Forceps	1

21	Denis Brown Tonsil Holding Forceps	1
22	Tonsil Scissors Straight	1
23	Tonsil Scissors Curved	1
24	Jennings Mouth Gag	1
25	Draffin Bipod Stand with Plates	1

Product Code:





Product	Size	Code
Tonsillectomy Set	-	22M09



Tracheotomy Set – 22M10

Advin Health Care manufacturer Tracheotomy Set Instrument Set is international quality Standard.

Advanced Features:

-  Smooth Surface
-  Made in High Grade Medical Material
-  Corrosion resistance
-  Autoclavable



Set of instruments:

SR. NO.	Product	QTY
1	SS tray 12 x 10 With cover	1
2	SS bowl 4"	1
3	Kidney Tray 8"	1
4	Sponge Holding 10"	1
5	Bp handle No - 3	1
6	Needle Holder 6"	1
7	Suture Cutting Scissor	1
8	Tracheotomy Dilator	2
9	Adson Forceps Non - Tooth 5"	1
10	Adson Forceps tooth - 5"	1
11	Mosquito Forceps ST 5"	4
12	Mosquito Forceps CVD 5"	4
13	Artery Forceps ST 6"	2
14	Artery Forceps CVD 6"	2
15	Metzabaum Scissor 5"	1
16	Towel Clamp Forceps 5"	4





Product Code:

Product	Size	Code
Tracheostomy Instrument Set	-	22M10

Micro Laryngeal Set – 22M11

Advin Health Care manufacturer Micro Laryngeal Set is International quality Standard.

Advanced Features:

-  Smooth Surface
-  Made in High Grade Medical Material
-  Corrosion resistance
-  Autoclavable

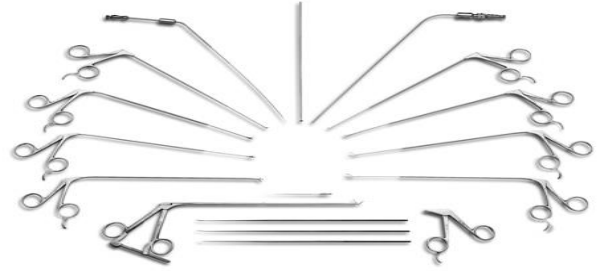

Set of instruments

SR. NO.	Product	QTY
1	Micro Laryngeal Forceps Serrated Jaw 25cm, 35cm	1
2	Micro Laryngeal Forceps Cup Jaw Straight	1
3	Micro Laryngeal Scissors Straight 25cm	1
4	Foreign Body Forceps 25,35,45,55cm	1
5	Biopsy Cup Forceps 25,35,45,55cm	1
6	Laryngeal Suction Tube 25cm, 35cm	1
7	Bronchoscope Suction Tube 35cm, 45cm	1
8	Micro Laryngeal Round Knife 45	1
9	Micro Laryngeal Plaster Knife	1
10	Micro Laryngeal Probe 90	1
11	Micro Laryngeal Sickle Knife	1
12	Micro Laryngeal Swab Holder 984, 984A - Holder for Micro Laryngeal Instrument	1
13	Anterior Commissure Laryngoscope with Fiber Optic Carrier Small/Med/Large	1
14	Laryngoscope Holder and Chest Supporter	1

Product Code:

Product	Size	Code
Micro Laryngeal Set	-	22M11

Harmonic Tuning Fork – 22N01

Advin Health Care Provides Harmonic Tuning Fork with international quality Standard.

Advanced Features:

- 🔊 Harmonic spectrum 8 pc set contains a full octave of weighted tuning forks (C, D, E, F, G, A, B, C)
- 🔊 They create a series of overtones to help you relax and center yourself. Each interval relates to a different state of consciousness and body posture
- 🔊 Made from Stainless steel
- 🔊 Corrosion Proof



Product Code:

Product	Size	Code
Harmonic Tuning Fork	-	22N01

Advin Health Care

Tuning Fork – 22N02

Advin Health Care manufacturer Advin Tuning Fork with international quality Standard. Tuning forks are an often-opted method of testing for certain types of hearing loss.

A doctor first holds a humming tuning fork to your skull and, using a stopwatch, monitors how long you can hear it. The doctor then strikes the tuning fork again and monitors how long you can hear it when it's held next to your ear. This is a set of three tuning forks with three different electromagnetic waves.

Advanced Features:

- 👂 A tuning fork is a metal instrument with a handle and two prongs or tines
- 👂 Tuning forks, will vibrate at a set frequency to produce a musical tone when struck
- 👂 The forks are made of stainless-steel material.
- 👂 They are resistant to corrosion and abrasion
- 👂 It can be used for a long time
- 👂 They produce sound waves of 128 Hz, 256 Hz and 512 Hz respectively



Product Code:

Product	Size	Code
Tuning Fork	128 Hz	22N02A
Tuning Fork	256 Hz	22N02B
Tuning Fork	512 Hz	22N02C
Tuning Fork	1024 Hz	22N02D



EXPORT MORE THAN
85 COUNTRIES

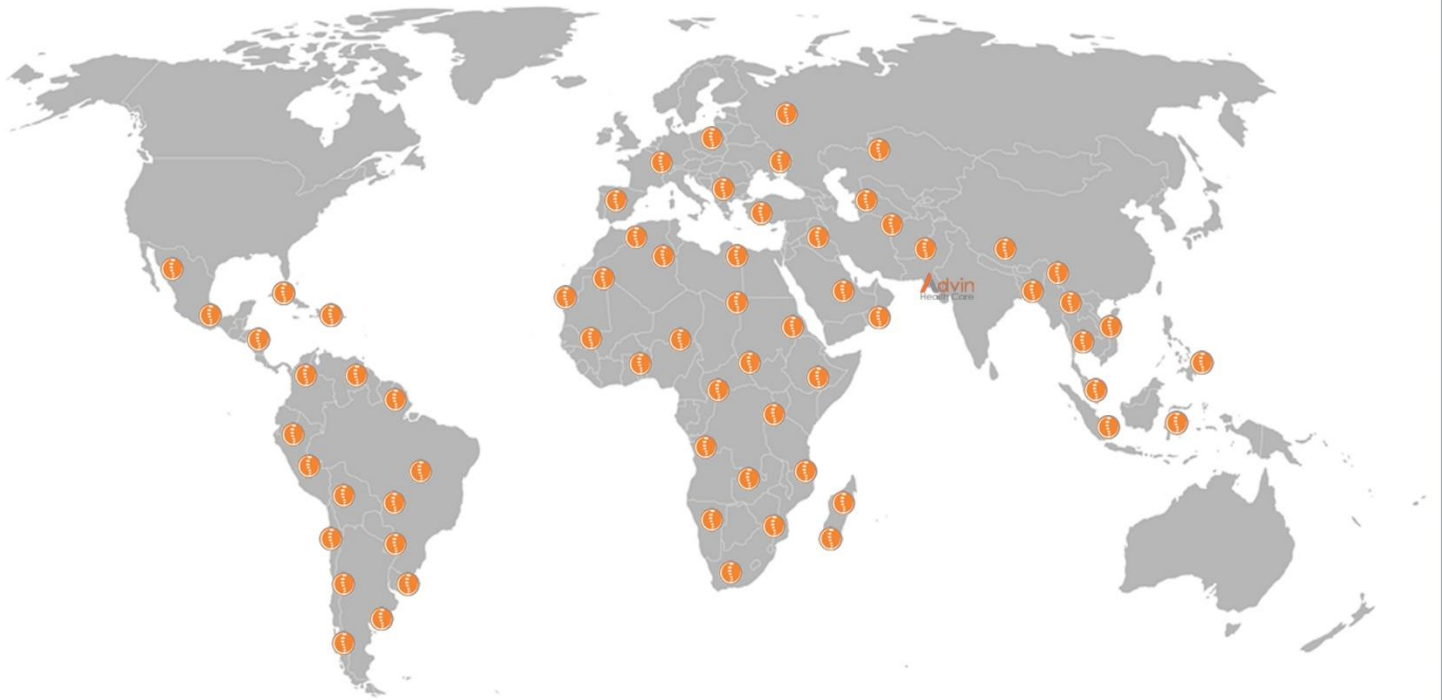

JOIN OUR
GLOBAL NETWORK



exports@advinhealthcare.com



www.advinhealthcare.com
www.advinurology.com



+91 7600 72 72 50